



**TFortis**

---

Multifunction Gigabit Managed Switch  
with PoE/PoE+ (IEEE802.3af/at) support  
and integrated UPS  
for connecting six IP cameras

PSW-2G6F+UPS-Box

---

# **Operating Manual**

Version 1

## Warning!

---



Power supply elements are under high voltage. It is strictly forbidden to touch conducting elements of the power supply unit under voltage.



Do not connect the computer to a port without a TH jumper installed on it.



If TFortis TH camera housings are not used, remove the TH jumpers.



Maximum PoE load should not exceed 160 W.



SFP port operates only at 1000 Mbps. Fast Ethernet SFP modules will not operate.



To ensure proper operation of lightning protection:

- provide proper grounding according to the Electrical Code;
- use a shielded twisted pair with shielded RJ45 connectors;
- use the minimum possible length of the twisted pair and power supply cables



To fully disconnect the switch, cut 230 VAC power supply and disconnect the backup battery wire for 10 seconds.



Before removing the backup battery compartment and the electronic unit, disconnect the wires.

# Contents

---

<b>1 Purpose</b> .....	4
<b>2 Features</b> .....	4
<b>3 Description</b> .....	7
3.1 Appearance .....	7
3.2 Cabinet .....	8
3.3 Optical distribution frame .....	8
3.4 Electronic unit .....	9
3.4.1 PoE jumpers .....	10
3.4.2 START button .....	11
3.4.3 CPU button .....	12
3.4.4 DEFAULT button.....	12
3.4.5 CPU indicator.....	12
3.4.6 DEFAULT indicator .....	12
3.4.7 PoE indicators.....	12
3.4.8 LINK indicators.....	12
3.4.9 Power indicators .....	12
3.4.10 Polarity mistake indicators.....	12
3.4.11 NORM indicator .....	12
3.4.12 ALARM indicator .....	12
3.5 Power supply unit.....	12
3.6 Tamper sensor .....	15
3.7 Integrated lightning protection .....	16
3.8 Additional functions.....	16
3.8.1 Cold start for TFortis TH camera housings.....	16
3.8.2 Restarting cameras in case of hanging .....	17
3.8.3 Cable tester .....	18
3.8.4 Remote camera polling .....	18
3.9 Built-in UPS .....	18
3.9.1 Switching to battery power .....	19
3.9.2 Battery charging.....	20
3.9.3 Battery discharge .....	20
3.9.4 Cold start .....	22
3.9.5 Battery function check.....	23
<b>4 Technical specifications</b> .....	23
<b>5 Operating conditions</b> .....	25
<b>6 Preliminary setting</b> .....	25
6.1 Resetting the switch to factory settings .....	25
6.2 IP address setting .....	25
6.3 User name and password setting.....	26
6.4 Setting PoE on the ports .....	26
6.5 Activating camera housing preheating .....	27
6.6 Activation of redundancy protocols.....	27
<b>7 Installation of the switch</b> .....	27
7.1 Installation of the cabinet on the wall.....	29
7.2 Installation of the cabinet on lamp posts .....	29
7.3 Optical connections.....	30
7.4 Electronic unit mounting.....	30
7.5 Battery installation.....	31
7.6 Power supply connection .....	32
7.7 Camera connection.....	32
<b>8 Manufacturer's warranty</b> .....	33
<b>9 Technical support</b> .....	33

# 1 Purpose

**PSW-2G6F+UPS-Box** is a multifunction gigabit managed outdoor switch with a built-in UPS, built-in optical distribution frame and PoE+ support designed for building IP video surveillance networks.

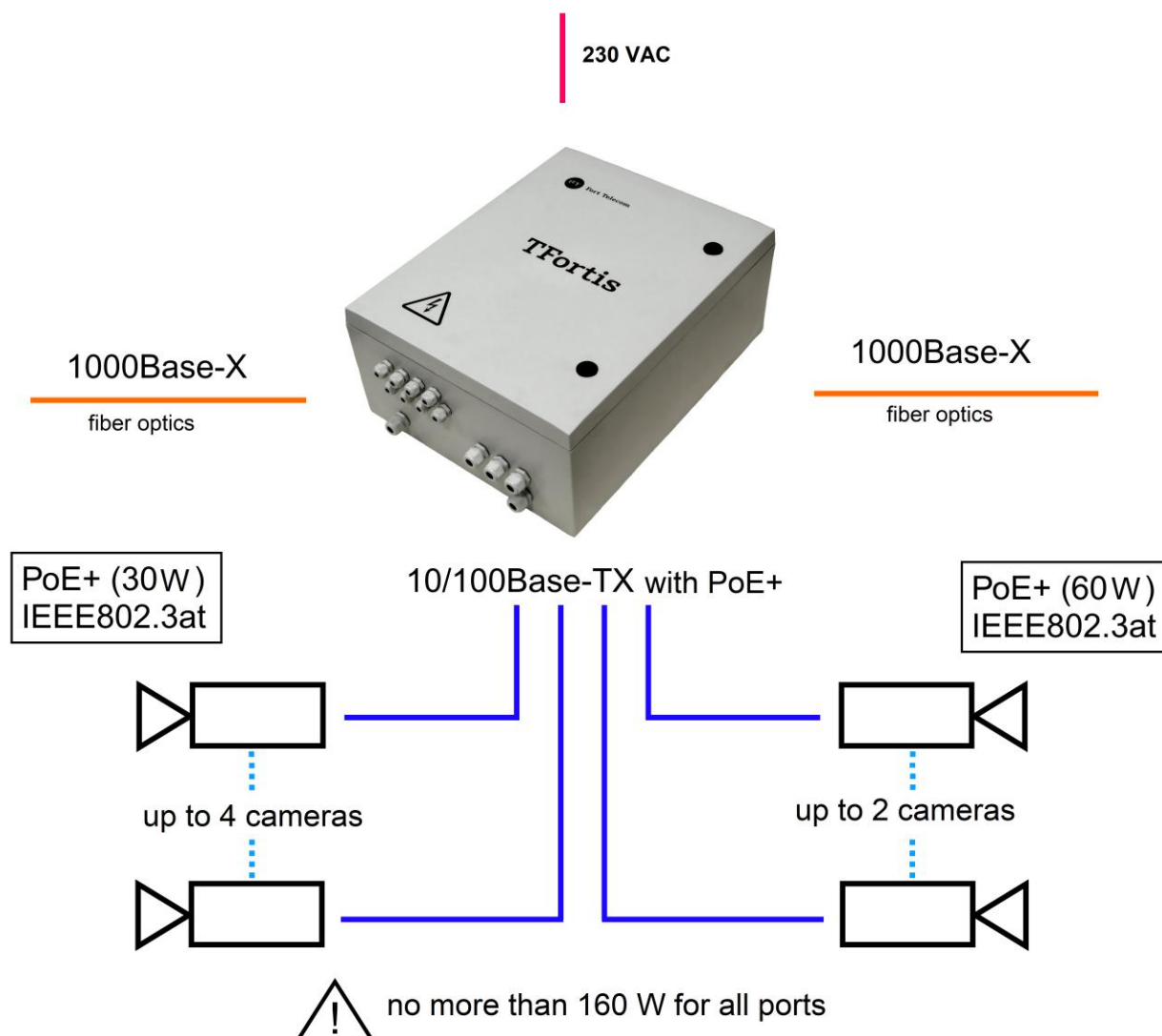

Figure 1 – PSW-2G6F+UPS-Box connection scheme

## 2 Features

### Weatherproof design

The switch enclosure is made of reinforced polycarbonate and is absolutely corrosion-resistant. The switch design and fiber glass reinforcement provide the maximum possible impact protection rating (IK10). Dust and moisture protection – IP66.

## **Operation in extreme temperatures**

The switch is built based on industrial hardware with a wide range of operating temperatures. Application of industrial SFP modules ensures normal operation in the temperature range from minus 60°C to plus 50°C.

## **High performance gigabit switch**

The key element of the switch is high performance Marvell chip, which is able to process a large volume of traffic coming from the IP cameras.

## **PoE+ support**

All ports support PoE+ (IEEE802.3at). Ports 1 and 2 support double PoE+, which makes it possible to provide 60 W using a standard twisted pair. This feature is extremely useful for energy-consuming PTZ cameras.

## **Power supply of camera housings via PoE**

During operation with TFortis TH camera housings, the switch uses a standard twisted pair to power both the camera and the camera housing via PoE. For safe and guaranteed start of video cameras in freezing weather, TFortis TH equipment allows for preheating of camera housings.

## **Uninterrupted power supply for the whole system**

The entire system has power backup, because the switch is equipped with UPS and the cameras can be supplied by PoE.

## **Resistance to 380 V voltage.**

If 380V voltage is supplied to the switch, the switch will be powered from the battery and the whole system will continue to operate from the backup power supply.

## **Built-in optical distribution frame**

The optical distribution frame allows for optical cable splicing inside the switch and connecting it to SFP modules.

## **Connection to 230VAC**

A built-in power supply unit ensures direct connection to 230VAC power supply, eliminating the need for additional power supply units.

### **Lightning protection**

A built-in lightning protection for Ethernet ports and 230VAC power supply protects the switch and connected cameras from surges caused by electrostatic discharges.

### **Automatic cameras restart in case of hanging**

The switch controls operation of the camera. In case of hanging, the switch will reboot the camera automatically over PoE. It allows to create unattended IP video surveillance networks.

### **Operation in a ring or a chain topology**

Two gigabit ports allow to connect switches in a chain. Support of STP/RSTP protocols allows to create ring topologies, which significantly improves fault tolerance of the system.

### **Unauthorized access control**

The switch enclosure has a tamper sensor (a sealed switch). Opening of the cabinet door will generate an alarm message to be sent to the server via SNMP or Syslog protocols.

## 3 Description

---

### 3.1 Appearance



Figure 3.1.1 – PSW-2G6F+UPS-Box – external appearance



Figure 3.1.2 – PSW-2G6F+UPS-Box – interior

## 3.2 Cabinet

### Cabinet features

- 100% corrosion protection due to glass-filled polycarbonate
- IK10 impact protection rating due to fiber glass reinforcement
- Dust and moisture protection rating – IP66.
- Fire resistance – UL94-5VA
- Electrical insulation – 1500VDC
- UV resistance – UL 746C

## 3.3 Optical distribution frame

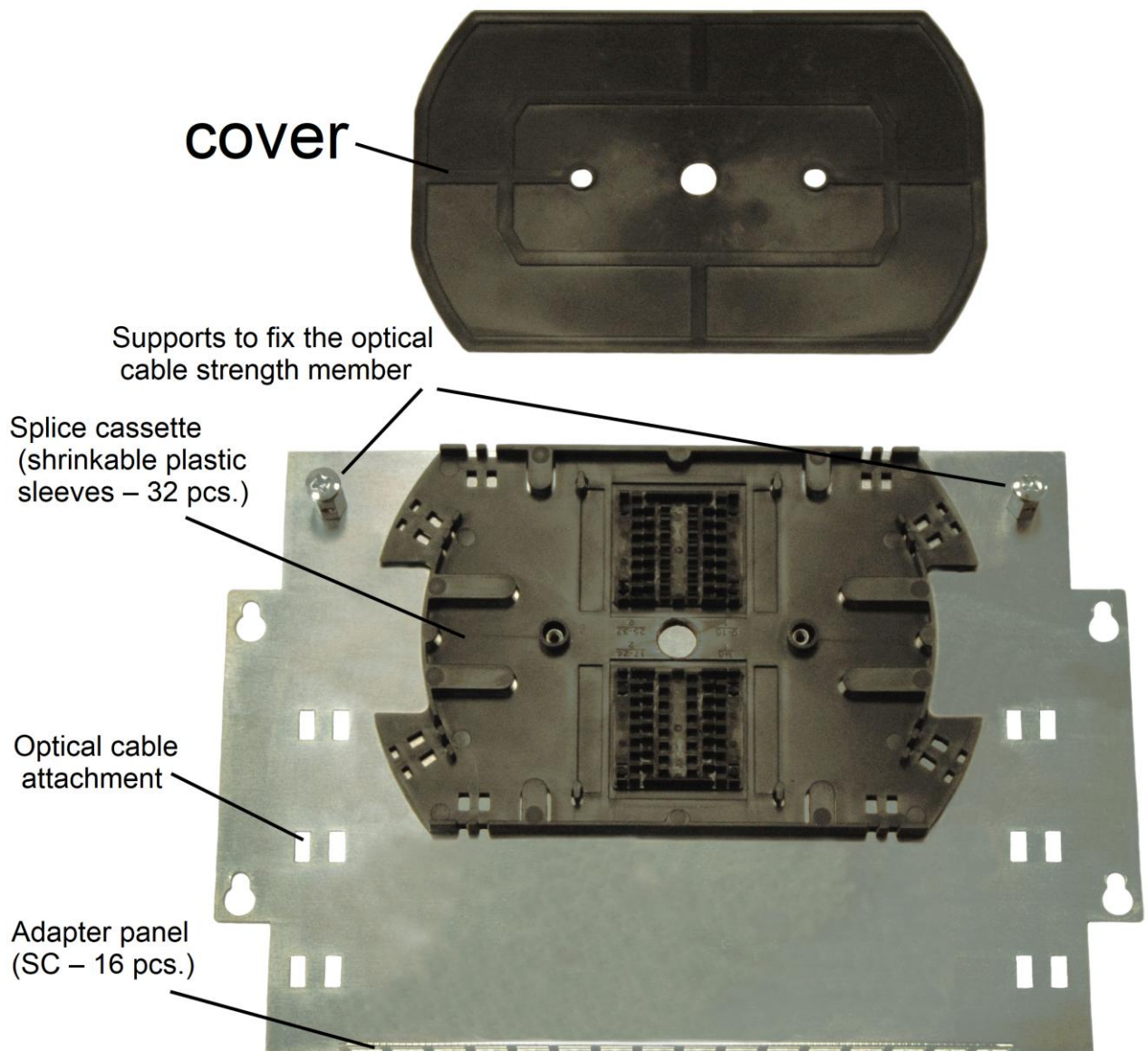

Figure 3.3 – Optical distribution frame.



### 3.4 Electronic unit

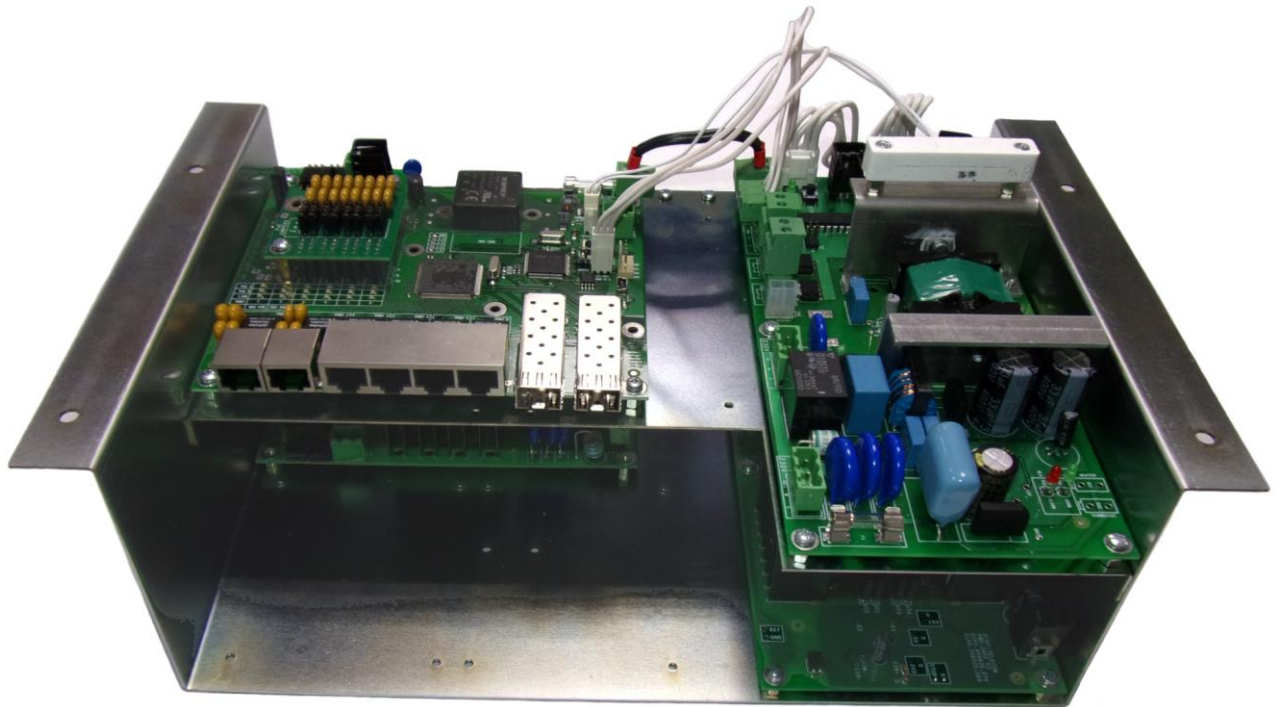

Figure 3.4.1 – Switch board and power supply unit board

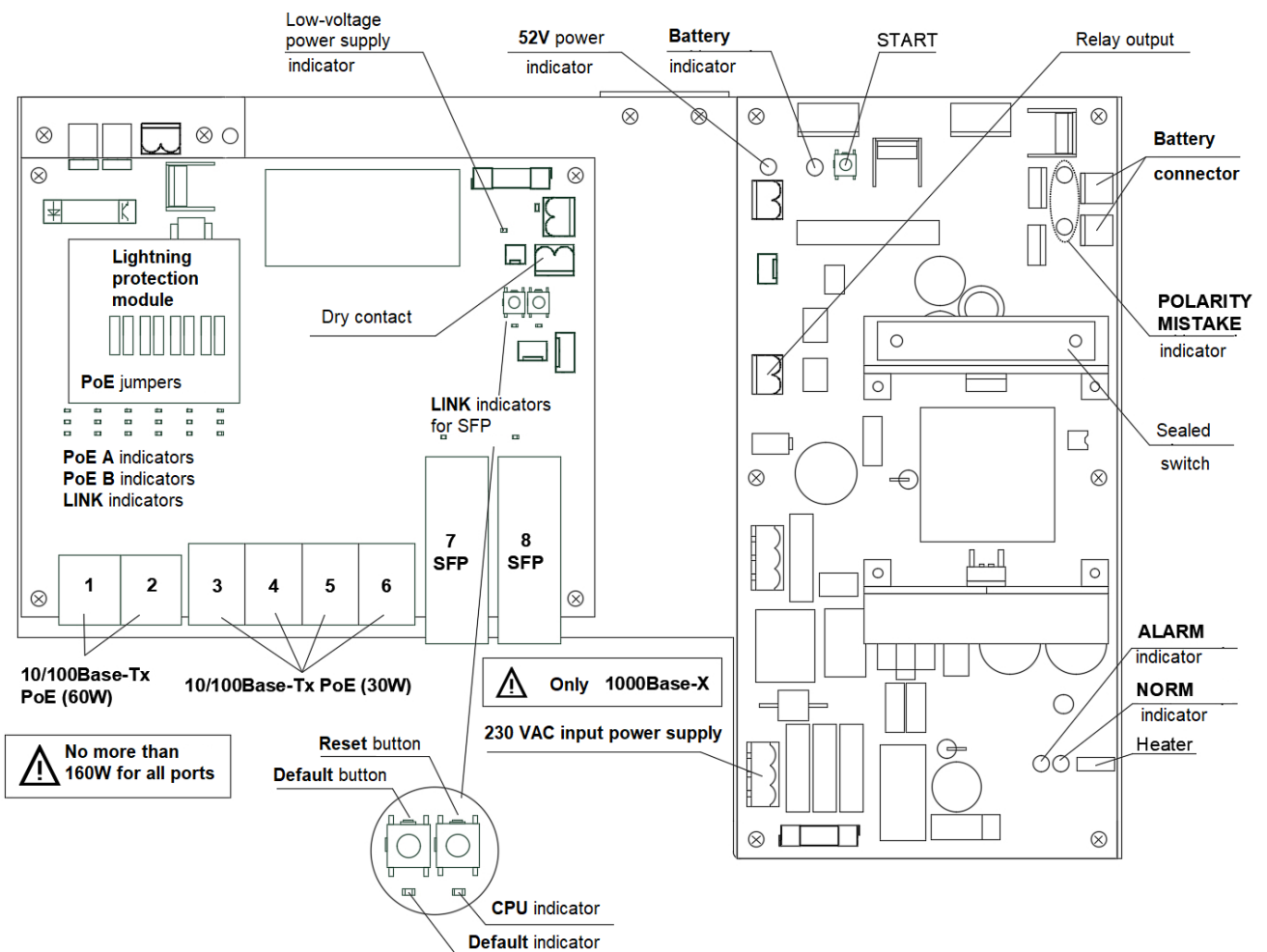
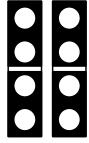
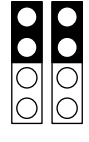
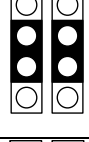
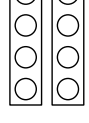

Figure 3.4.2 – Layout of components inside PSW-2G6F+UPS-Box

### 3.4.1 PoE jumpers

Ports of PSW-2G6F+UPS-Box support PoE+ (IEEE802.3at) power supply of up to 30 W. Selection of power supply options depends on the jumper configuration (Table 3.4.1).

Table 3.4.1 Configuration of PoE jumpers

	Pairs 1, 2 and 3, 6 (Option A)	Pairs 4, 5 and 7, 8 (Option B)	Item
	IEEE802.3at (video camera)	Passive PoE (TFortis TH camera housing)	IV
	IEEE802.3at (video camera)	-	III
	-	IEEE802.3at (video camera)	II
	-	-	I

**IMPORTANT!** If TFortis TH camera housings are not used, remove the TH jumpers. Otherwise, the camera will start using the power intended for the camera housing. If this occurs, automatic camera restart in case of hanging will not operate.

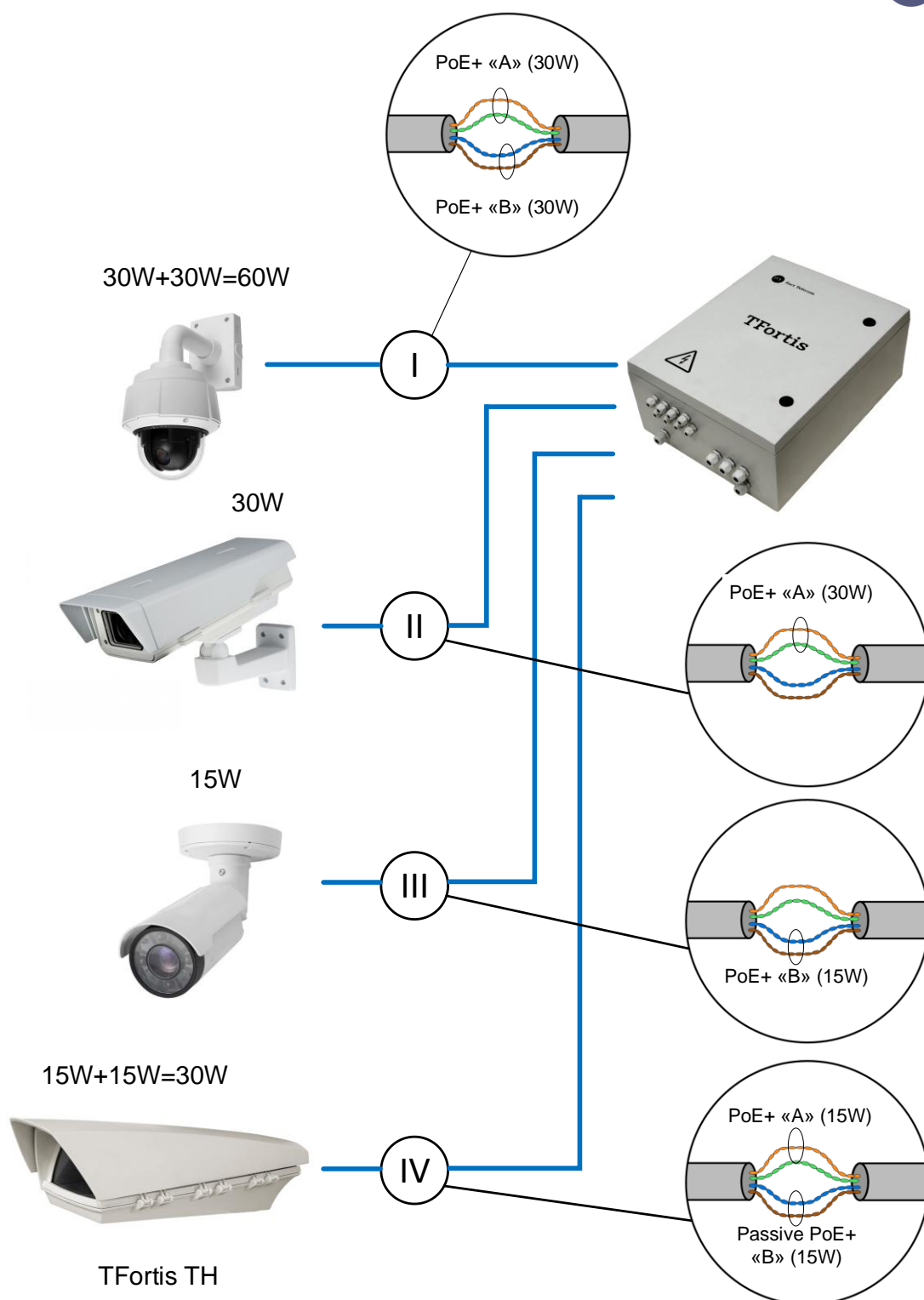

Figure 3.4.3 – PoE power supply scheme, various options.

### 3.4.2 START button

To start the system supply from the battery, press the START button with 230 VAC off.

### **3.4.3 CPU button**

To restart the switch, short press the CPU button.

### **3.4.4 DEFAULT button**

To restore factory settings, press the DEFAULT button and hold it down for about 15 seconds. The DEFAULT indicator should set ON at this point.

### **3.4.5 CPU indicator**

During normal processor operation, the CPU indicator should blink in 2-second intervals (1 second ON, 1 second OFF)

### **3.4.6 DEFAULT indicator**

DEFAULT indicator is ON when the device has the factory settings (IP 192.168.0.1).

### **3.4.7 PoE indicators**

The PoE A indicator is ON when power is supplied over data (pairs 1, 2 and 3, 6). The PoE B indicator is ON when power is supplied by free pairs (pairs 4, 5 and 7, 8).

### **3.4.8 LINK indicators**

Blinking of LINK indicators shows that data are transmitted via the corresponding port.

### **3.4.9 Power indicators**

Power indicators show the presence of supply voltage on the switch boards.

### **3.4.10 Polarity mistake indicators**

Polarity mistake indicators show wrong connection to the battery.

### **3.4.11 NORM indicator**

The switch is powered from the power supply.

### **3.4.12 ALARM indicator**

Power supply voltage is not applied to the switch due to increased or decreased voltage.

## **3.5 Power supply unit**

Power supply unit is a separate element of the switch located in the bottom right part of the cabinet. This is a small removable metal part with a grounding pin,

terminal blocks and a circuit breaker (Figure 3.5.1). The power supply unit can be easily removed from the switch enclosure to provide free access to the optical distribution frame (Figure 3.5.2).

Input supply voltage of 230 VAC comes to the terminals with a cross-section of up to 2.5 mm<sup>2</sup>).

The circuit breaker is designed to connect and disconnect the supply voltage of 230 VAC.

Note that to fully de-energize the device, the battery connectors should be disconnected (Figure 3.5.4).



Figure 3.5.1 – Power supply unit.



Figure 3.5.2 – Power supply unit with removed fastener.



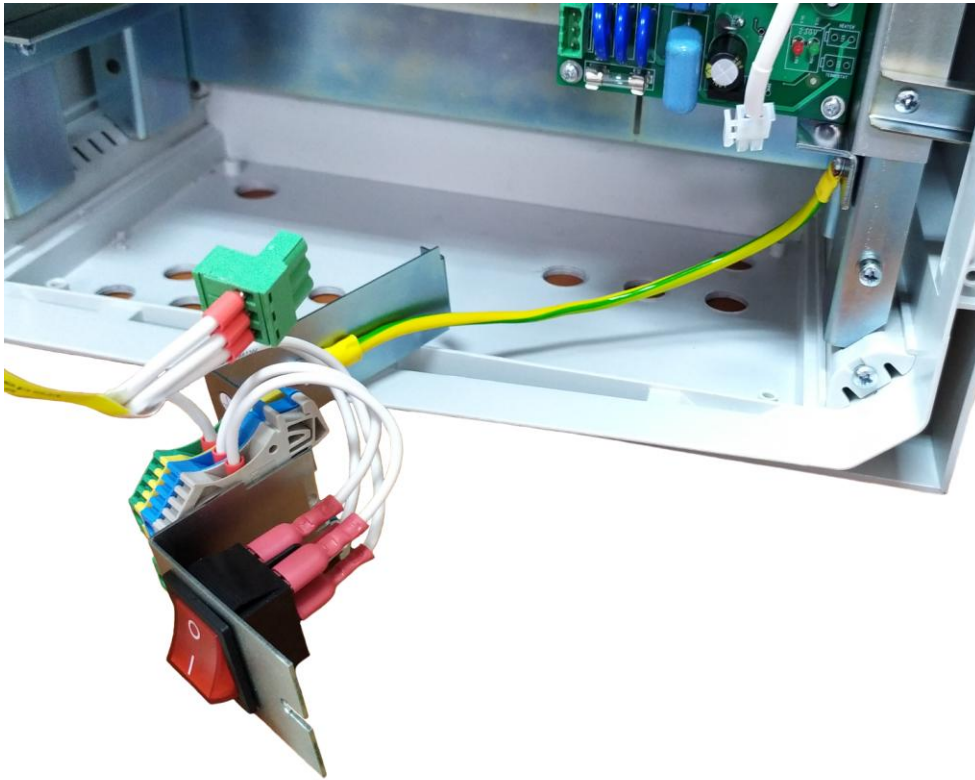

Figure 3.5.3 – 230 VAC power supply terminal is disconnected.

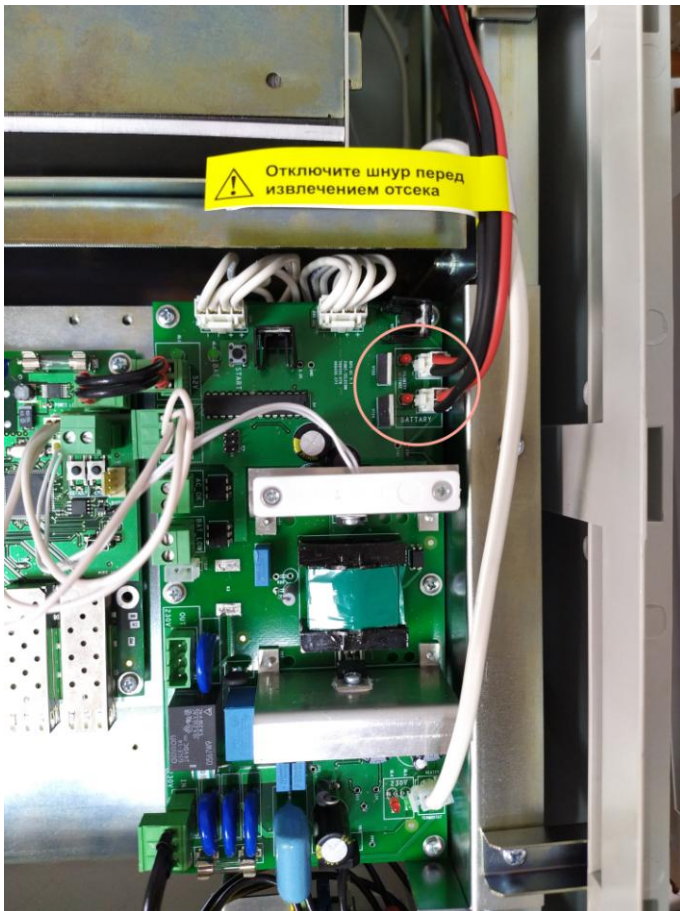

Figure 3.5.4 – Disable the battery to fully de-energize the device.

### 3.6 Tamper sensor

The switch enclosure has a tamper sensor (a sealed switch). The sealed switch is connected to SENSOR 2 contact. The cabinet door opening will generate an alarm message to be sent to the server via SNMP Traps, SMTP or Syslog protocols (see detailed information in the Configuration Manual).

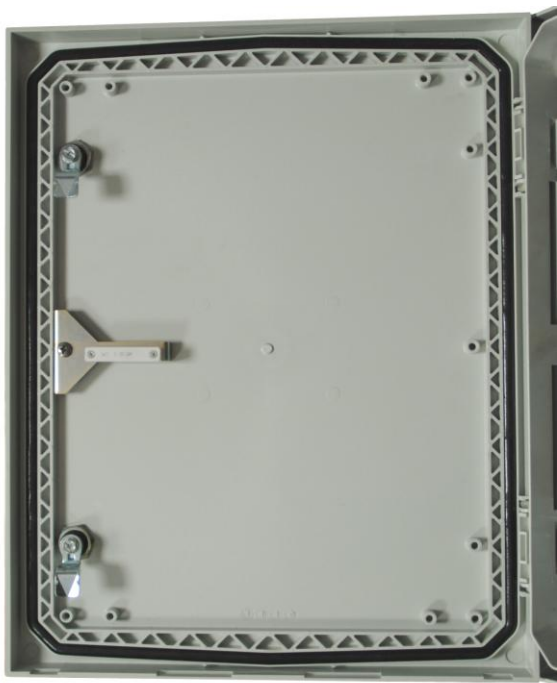

Figure 3.6.1 – Tamper sensor on the switch cover

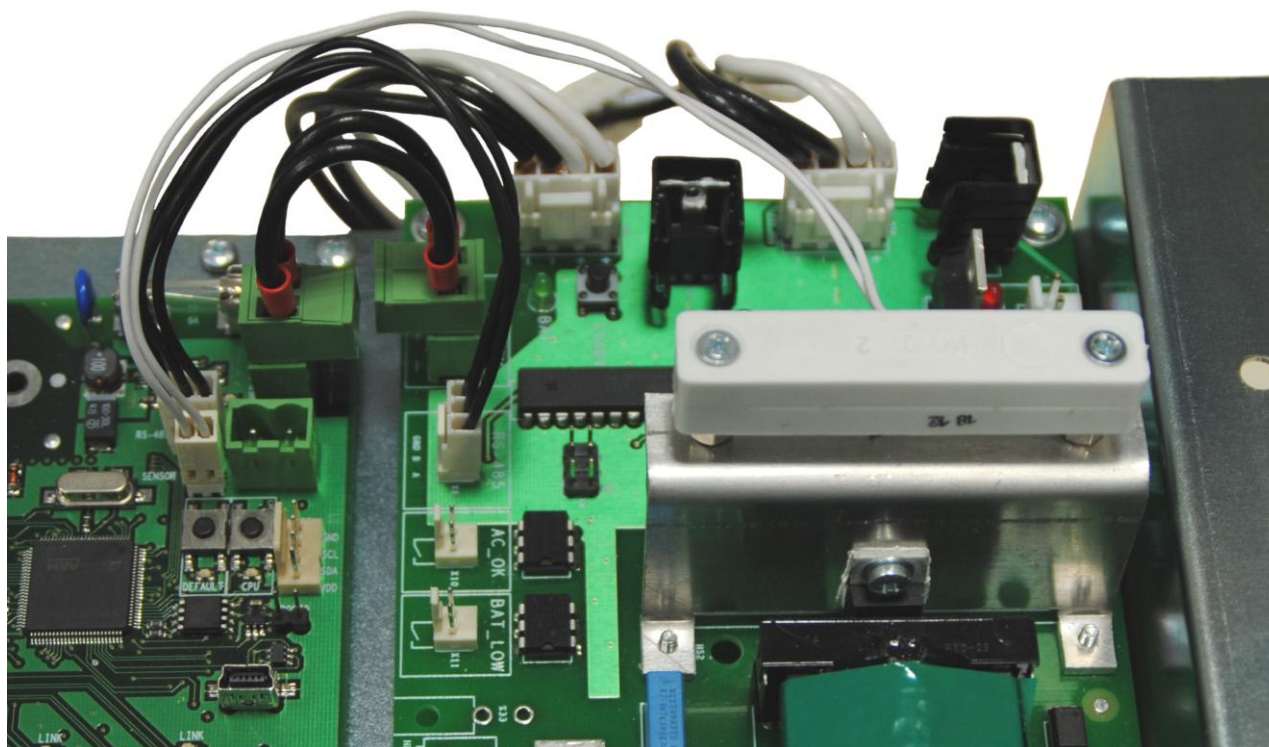

Figure 3.6.2 – Tamper sensor on the switch enclosure **new**

### 3.7 Integrated lightning protection

PSW-2G6F+UPS-Box switch has built-in lightning protection modules that protect Ethernet ports and 230VAC power circuits from common-mode and differential electromagnetic interferences.

The switches are resistant to powerful microsecond pulse interferences according to GOST R 51317.4.5 standard as per Table 3.7.1 with performance criteria B (temporary disruption of performance or functioning with further recovery without operator's intervention).

Table 3.7.1

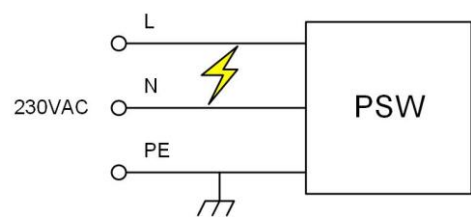
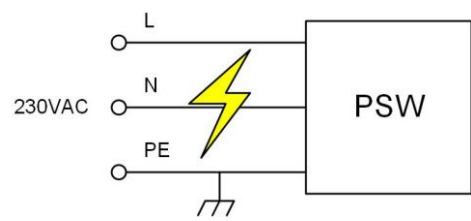
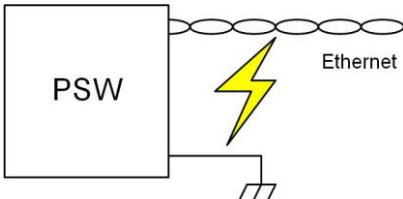
Port	Pulse
	2 kV
	4 kV
	2 kV

**IMPORTANT!** Grounding of the switch is mandatory for lightning protection.

### 3.8 Additional functions

#### 3.8.1 Cold start for TFortis TH camera housings

The most critical moment in camera operation is its start at low temperature. Cold start may result in failure of an expensive camera. To prevent that PSW-2G6F+UPS-Box switch has a preliminary heating function of TFortis TH camera



housings. When power is supplied, it first goes to the heating elements in the camera housing, 1 hour later the camera itself it supplied. This delay provides comfortable conditions for the camera start and prevents failures of expensive equipment. The Comfort Start option is available via the web interface in the Special Function section (see the Configuration Manual).

**IMPORTANT!** The Cold Start function is available only for TFortis TH camera housings.

### 3.8.2 Restarting cameras in case of hanging

PSW-2G6F+UPS-Box continuously monitors connection of the camera to the switch. There are three ways to detect camera hanging:

- No connection to the camera (Link)
- No response to service requests (Ping)
- Reduction of port speed below the established limit (Speed)

#### Video camera restart using Link signal

The switch continuously (once a minute) monitors the Link signal from the IP camera. If the switch fails to detect the Link signal, then a one-minute timer is started, and after that the connection is checked again. If the Link signal does not appear, the switch removes power for 10 seconds and supplies it again, rebooting the camera. In other words, if the switch fails to see the Link signal from the camera twice in succession at an interval of 1 minute, it reboots the camera. The Auto Restart option is available via the web interface in the Special Function section (see the Configuration Manual).

#### Camera restart due to no response to Ping request

The switch constantly (1 time per minute) polls the IP camera. If the switch does not receive a response, then a one-minute timer is started, during this time the poll is repeated every 10 seconds. If the camera has not responded within a minute, the switch removes power from the camera for 10 seconds and supplies it again, rebooting the camera. If the camera has responded at least once, the

switch makes a decision that the camera is functional and starts the poll cycle again, polling the camera 1 time per minute. The Auto Restart option is available via the web interface in the Special Function section. To use this function, it is necessary to enter the IP address of the camera. Make sure your camera responds to PING (see the Configuration Manual).

### Camera restart in case of port speed reduction

The switch continuously monitors the speed on the port the camera is connected to. If the flow speed goes below the established limit and fails to restore, the switch makes a decision that the camera is hanging and reboots it. The user may specify the limit values (see the Configuration Manual).

#### 3.8.3 Cable tester

The switch can function as a virtual cable tester (VCT), which allows to determine the breakage of the twisted pair, short-circuiting of the twisted pair wires, cable disconnection from the camera, distance from the switch to the fault. The cable tester is used to test pairs that transmit data (**1, 2 and 3, 6**). Note that the accuracy of the cable tester is **± 2 meters**.

By default, VCT operates on an average algorithm and does not take into account the specific features of a particular cable, which can affect the accuracy of the measurement. To improve the accuracy of the cable tester, it is recommended to calibrate it. Note that calibration is not recommended for cables **shorter than 10 meters**.

#### 3.8.4 Remote camera polling

Using the switch, it is possible to ping any device on the network through the web interface, which is convenient when solving network problems.

### 3.9 Built-in UPS

The built-in UPS is a separate removable compartment that includes a metal housing with a backup battery inside it. In the bottom of the compartment, there is a heating element. Radiators and heat-insulating pads provide uniform heating of the battery in cold weather conditions. The UPS board has a thermostatic element that allows to maintain the temperature required for proper battery operation.

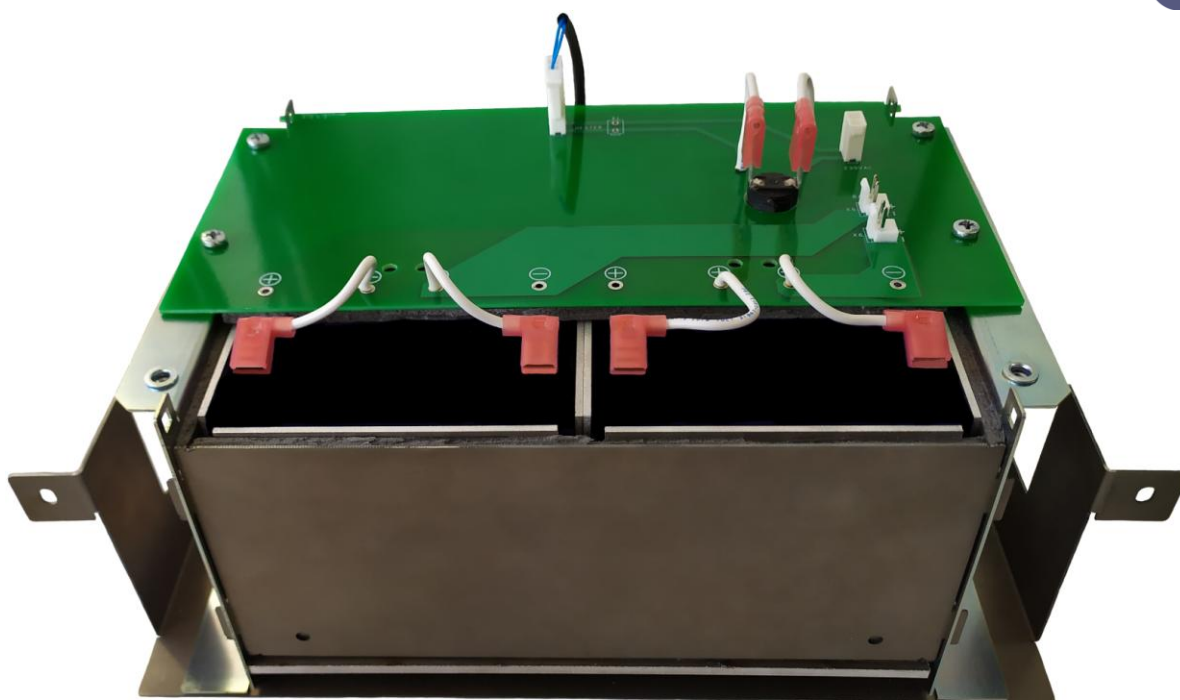

Figure 3.9 – Backup battery compartment.

### 3.9.1 Switching to battery power

The switch controls 230 VAC input voltage. If the input voltage is above 260V or below 180V, the switch is disconnected from the external power supply and operates from the battery power.

**IMPORTANT!** Switching to battery power does not cause interruption in operation of the switch.

Deviations in the external power supply may be caused by:

- phase imbalance
- loss of neutral (380 V)
- socket error (380 V)

Table 3.9.1 – 230 VAC external power supply state indicators

Power	Description
NORM	The switch is powered from 230 VAC external power supply
ALARM	Power supply voltage is not applied to the switch due to increased or decreased voltage.

**IMPORTANT!** When the power is turned on, the ALARM indicator always lights up. Only after 5-10 seconds the device goes into normal operation mode.

### 3.9.2 Battery charging

When 230 VAC external power supply is available, it will power the switch and at the same time charge the battery. Charging is implemented in two stages. First, the battery is charged by direct current (CC=1A). With the increase in battery power, battery voltage increases too. As soon as it reaches 27V, charging converts to direct voltage (CV=27V). In this mode voltage gets stable and current drops with the increase in battery power. This approach ensures faster and more effective battery charging.

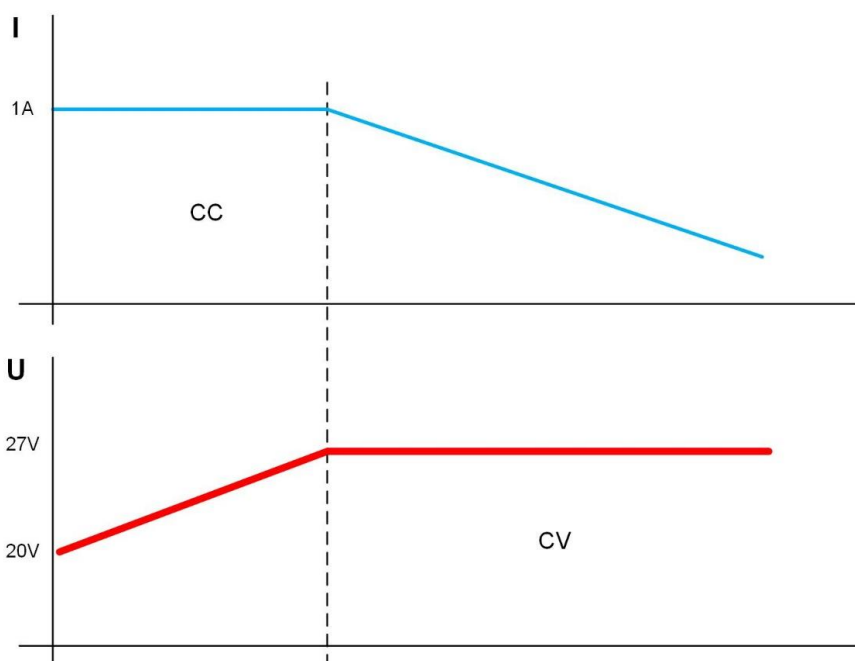

Figure 3.9.2 – Dependence of direct current and voltage on the battery power.

### 3.9.3 Battery discharge

In case of backup power supply, battery voltage drops from 27 V to the nominal 24 V, then the battery discharges gradually. At this stage the battery releases most of its power.

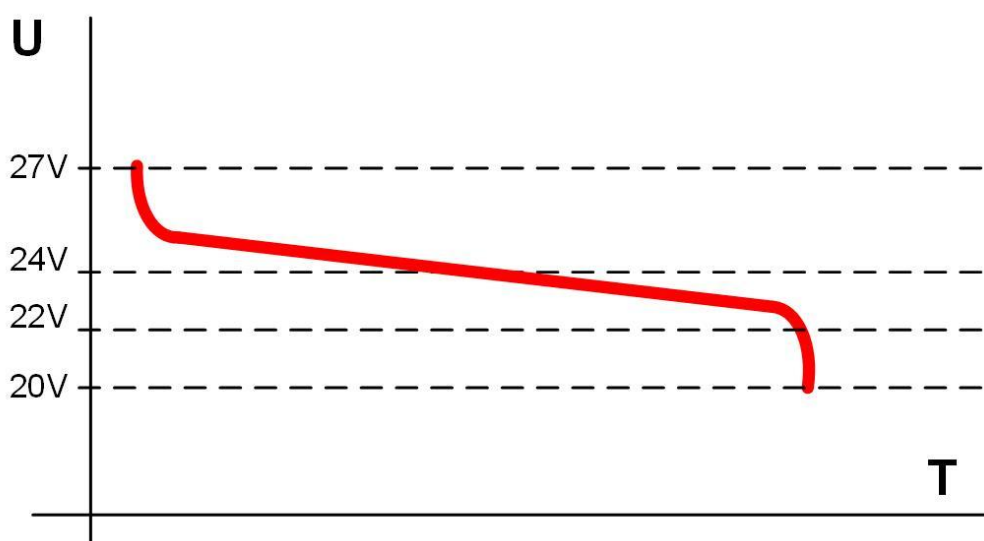









Figure 3.9.3 – Voltage drop during battery discharging.

When the threshold voltage of 22 V is achieved and most of the battery power is released, the system begins to send alarm messages about low battery charge and the upcoming disconnection using SNMP trap, Syslog, SMTP protocols (presetting required). When voltage drops to 20 V, the battery goes off. This allows to prevent deep discharging of the battery.

Table 3.9.3.1 – BAT indicator

State	Description
	Battery disconnected or switch de-energized
	Battery charging
	Battery discharging
	Battery reached the critical discharge levels of 22V
where	
	indicator is OFF
	indicator is ON
	indicator 1 s ON, 1 s OFF
	indicator blinks 1 time in 4 seconds

Battery time depends on several factors: camera power consumption, ambient temperature, battery residual capacity. The most significant factor is camera power consumption.

Table 3.9.3.2 – Estimation of uninterrupted operation time

Load *, W	Time
0	18:00
10	9:00
20	7:00
30	5:20
40	4:30
50	3:40
60	3:00
70	2:20
80	1:50
90	1:30
100	1:10
110	1:00
120	0:55
130	0:50
140	0:48
150	0:46
160	0:44

\* Load is the total power of the cameras + loss of power in the twisted cable

\*\* In the camera documentation the manufacturer normally specifies the maximum power consumption with IR illumination and heating ON.

Note that Table 3.8.3.1 shows approximate battery life. These values are recommended for use during system design.

When operated from the battery, the switch estimates actual power consumption, remaining battery capacity and calculates remaining battery time. This information is available through WEB interface.

### 3.9.4 Cold start

The switch has the function of delayed start. The operating principle is as follows. If the external 230VAC power is missing and the switch is connected to battery, it will not start. The switch will only start when the external power is back on. This feature allows to save the battery power until the entire system starts. Only after 230VAC power is supplied to the switch, the batteries will perform power backup function.

In practice, usually the entire system is initially assembled and checked, and only after that 230 VAC power is supplied. Sometimes this process takes time. If there is no delayed start function, then after connecting the battery, the switch and cameras will start working immediately. Loads will gradually discharge the battery to a safe voltage. Deep discharge is prevented. However, when the battery is half-discharged for a long time, its capacity will drop. To prevent this, the delayed start function was implemented.

If you need to force start the switch operation from the battery in the absence of external power supply, you may use the cold start function. To do that, short press the START button. The switch will start. To deactivate the switch, you should disconnect at least one battery.

### **3.9.5 Battery function check**

Battery capacity is the amount of electricity given by a fully charged battery until it is discharged to reach the final voltage. Battery capacity changes throughout the service life. During operation, the capacity remains stable for a while, and then begins to gradually decrease (residual capacity).

Residual capacity can be estimated by special devices (battery capacity testers). It is recommended to check the battery condition once a year. Using a battery with low residual capacity reduces the uninterrupted operation time of the switch.

Switch batteries operate in the floating mode. The service life of the batteries if supplied in this kit is 5 years under normal conditions. When the switch operates with frequent power outages or in hot weather conditions, the battery degrades more rapidly. If it is not possible to test the battery as described above, we recommend replacing the battery every 2 years.

## **4 Technical specifications**

---

### Gigabit Ethernet ports

- 1000Base-X with SFP connector;
- Number of ports – 2;

### Fast Ethernet ports

- 10/100Base-Tx with RJ-45 connector;
- number of ports – 4;
- supports Auto-MDIX for port 10/100Base-Tx;
- supports IEEE 802.3x flow control;

- IEEE802.3at support for options A and B simultaneously up to 60 W for ports 1 and 2;
- IEEE802.3at support for option A or option B up to 30 W for ports 3 to 6;
- Passive PoE support (Option B) – 30 W;
- maximum output power per port – 60 W;
- maximum output power for all ports – 160 W;
- transmission distance – up to 100 m.

#### Main power supply

- voltage –230 VAC (187 to 253 V);
- Maximum power consumption – 320 W.
- battery characteristics
  - nominal voltage 12 V
  - capacity 12 A\*h;
  - dimensions 151x98x95 mm;
  - quantity – 2.

#### Design

- dimensions 500x400x210 mm
- maximum weight excluding the battery – 15 kg;
- maximum weight including the battery – 23 kg;
- environmental protection rating IP66;
- impact protection rating IK10
- cable glands
  - 4-8 mm cable – 8 pcs.
  - 6-12 mm cable – 5 pcs.

#### Reliability

- meantime between failures at least 75 000 hours (8.6 years).



## 5 Operating conditions

---

The switch is designed for 24-hour operation in outdoor conditions at an ambient temperature from –60 to +50 °C with industrial SFP modules.

It is recommended to install the switch in areas protected from direct sunlight (under roof overhang, on shaded sides of the building, etc.).

The switch remains fully functional after exposure to ambient temperatures from minus 60 °C to plus 50 °C.

## 6 Preliminary setting

---

It is recommended to do preliminary setting of the switch before installation. You can find a detailed instruction in the "Configuration Manual" at TFortis website (<https://tfortis.com/support/dokumentaciya-na-produkciyu/>).

### 6.1 Resetting the switch to factory settings

Before start, set the switch to default settings. To do this, press and hold the DEFAULT button until the DEFAULT indicator lights up. The default IP address of the switch is 192.168.0.1.

### 6.2 IP address setting

All software functions of the switch can be managed, configured and monitored using the built-in WEB interface and Telnet. Below is the description of WEB-based configuration. Configuration via Telnet (see the Configuration Manual).

The switch can be managed from remote stations at any point of the network via a standard web browser (for example, Microsoft Internet Explorer). The browser is a universal access tool and can directly access the switch using the HTTP protocol.

Connect any switch port to an Ethernet network. Note that if the device is configured over a network, the IP address of the management workstation should belong to the same IP network. For example, if the default IP address of the switch is 192.168.0.1, then the IP address of the workstation should be 192.168.0.x (where x is a number from 2 to 254); the default subnet mask is 255.255.255.0.

Open the web browser and enter the IP address `http://192.168.0.1`.

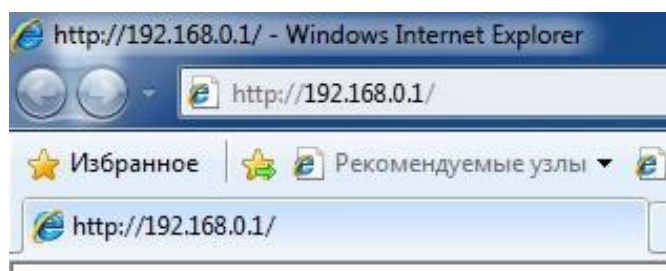

Figure 6.2 - Entering the IP address of the switch

### 6.3 User name and password setting

Until the "user name" and "password" are set, you will log in without entering this data. After the password is set, you will need to authenticate when you log in.

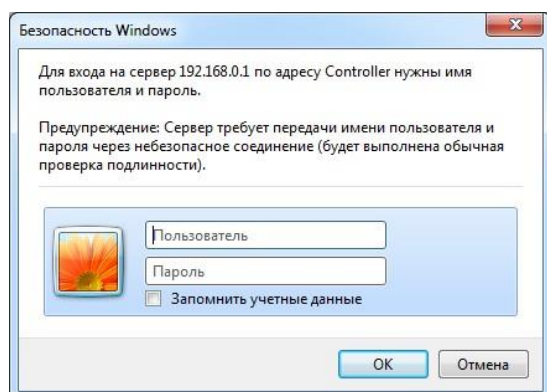

Figure 6.3 - Entering user name and password.

**IMPORTANT!** Note that the user name and password are case sensitive.

### 6.4 Setting PoE on the ports

PoE power supply is configured using jumpers (see Section 3.4.2). All connections should be performed with 230VAC power off.

**IMPORTANT!** Do not connect the computer to a port without a TH jumper installed on it.

## 6.5 Activating camera housing preheating

When the camera is started in freezing weather, it can fail to start or even break down. To solve this problem, use Comfort Start function. To do this, go to Comfort Start section on the Special Function tab and enable the option. By default, it is OFF. The function is available only with TFortis TH camera housings.

**IMPORTANT!** If this option is enabled after power is supplied to the switch, the cameras will start only after the Soft Start Time. To force start the cameras, press Manual Start.

## 6.6 Activation of redundancy protocols

If you connect the switches into a ring topology, then you need to enable the RSTP protocol. Otherwise, if there are alternative paths, your network will not be functional. By default, RSTP is turned off.

# 7 Installation of the switch

---

Remove the battery compartment before installation of the switch to reduce its weight (Figure 7.1). To do that, disconnect battery supply cables from their terminals on the board. Remove the shipping inserts (you do not need to reinstall them later). Lift the battery compartment and remove it from the enclosure.

Remove the electronic unit in the same manner (Figure 7.2)

**IMPORTANT!** Make sure you disconnect the cables.

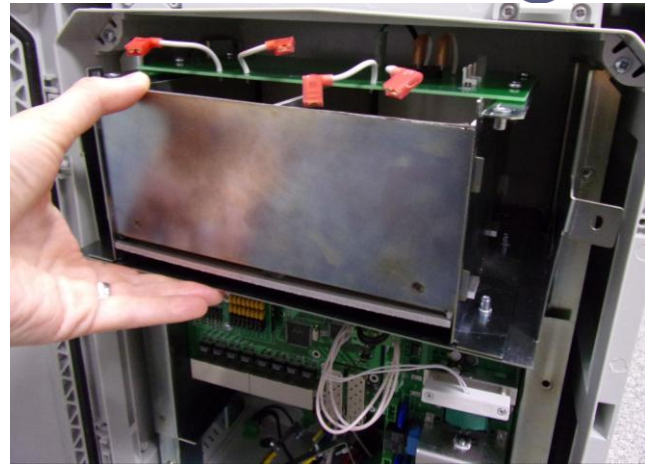

Figure 7.1 – Battery compartment removal

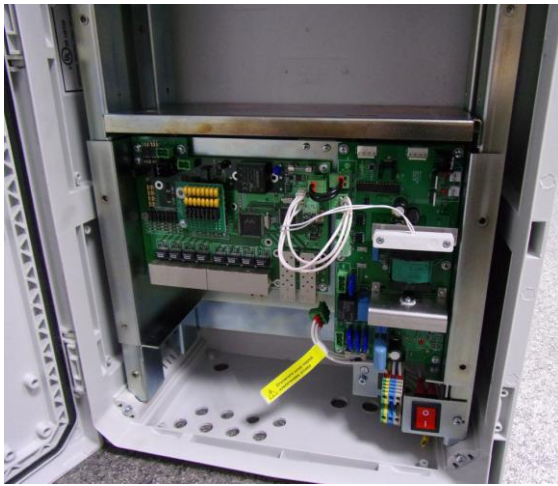

Figure 7.2 – Electronic unit removal.

## 7.1 Installation of the cabinet on the wall

The cabinet has four attachment points isolated from the interior. Marking of the attachment points is shown in Figure 7.3. The marking template is included with the packaging.

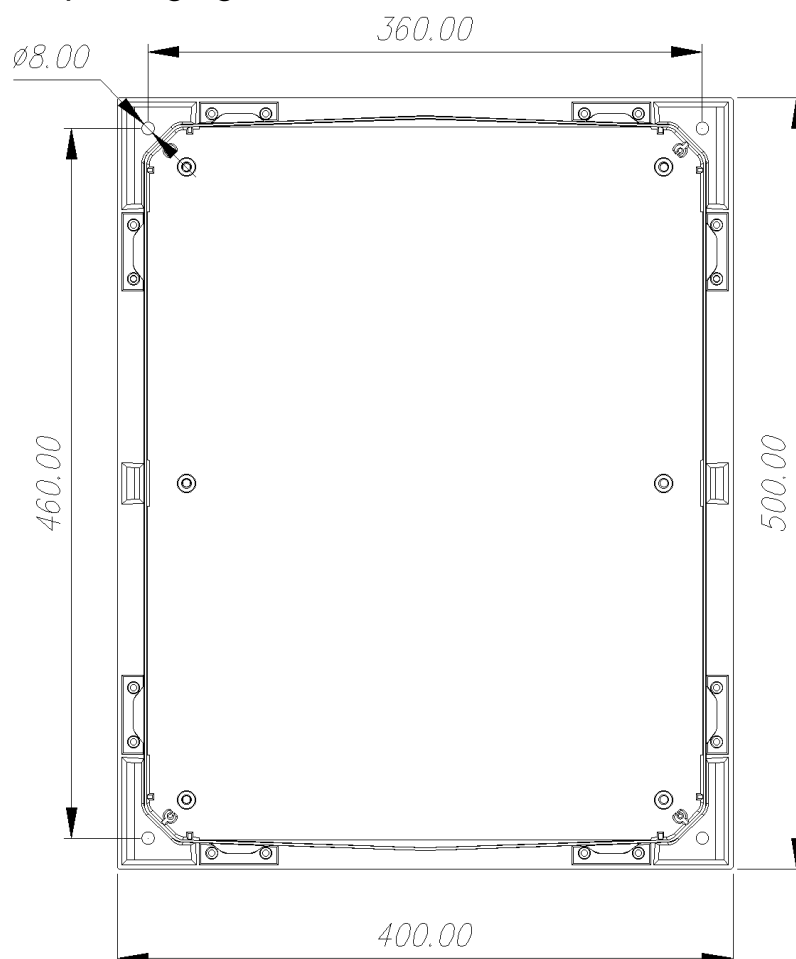

Figure 7.3 – Marking of attachment points

**IMPORTANT!** Drilling of the enclosure will lead to loss of the switch integrity and result in the loss of product warranty.

## 7.2 Installation of the cabinet on lamp posts

To mount the cabinet on the poles, use TFortis-2 pole mounting kit for square and round supports.



Figure 7.2 - TFortis-2 pole mounting kit

**IMPORTANT!** TFortis-2 pole mounting kit is not included in the scope of supply

### 7.3 Optical connections

The switch has an optical distribution frame. For ease of operation, the optical distribution frame can be removed from the cabinet. The optical cable is pulled into PG13.5 cable glands. The optical cable is attached to the metal base of the distribution frame with nylon ties or metal cable ties. To fix the optical cable strength member, metal supports with screws are used. Optical fibers are laid in a splice cassette for 32 shrinkable plastic sleeves. Welded pigtails are connected to SC adapters located on the adapter panel. Then the adapters are connected to SFP modules with the use of optical patch cords. It is allowed to connect the pigtails directly to SFP without any unnecessary connections.

**IMPORTANT!** Nylon ties, shrinkable plastic sleeves, pigtails and adapters are NOT included in the scope of supply.

### 7.4 Electronic unit mounting.

Electronic unit is a separate removable compartment. It has a metal plate with boards and a power supply unit located in two levels (see section 3.4). The



electronic unit is attached to the switch enclosure using M4 screws and shipping inserts. Before removing the unit, make sure that power supply cables and cables connecting the electronic unit to the battery are disconnected.

## 7.5 Battery installation

The switch is shipped with the battery removed. To install the battery into the switch, remove the battery compartment from the enclosure. The battery is attached to side guides using M4 screws and shipping inserts (you do not need to reinstall the shipping inserts later). **Before removing the battery compartment from the enclosure, disconnect the power supply cables from the battery.** The battery shelf has holes for the bolts that fix the battery compartment. To remove the compartment, you should lift it a little above the shelf. Make sure that the temperature sensor terminals do not get caught against the switch enclosure.

After removing the compartment, put it on a smooth surface. Open the cover of the compartment and put the battery into separate radiators. Close the cover. Connect cables to battery terminals according to Figure 7.5.

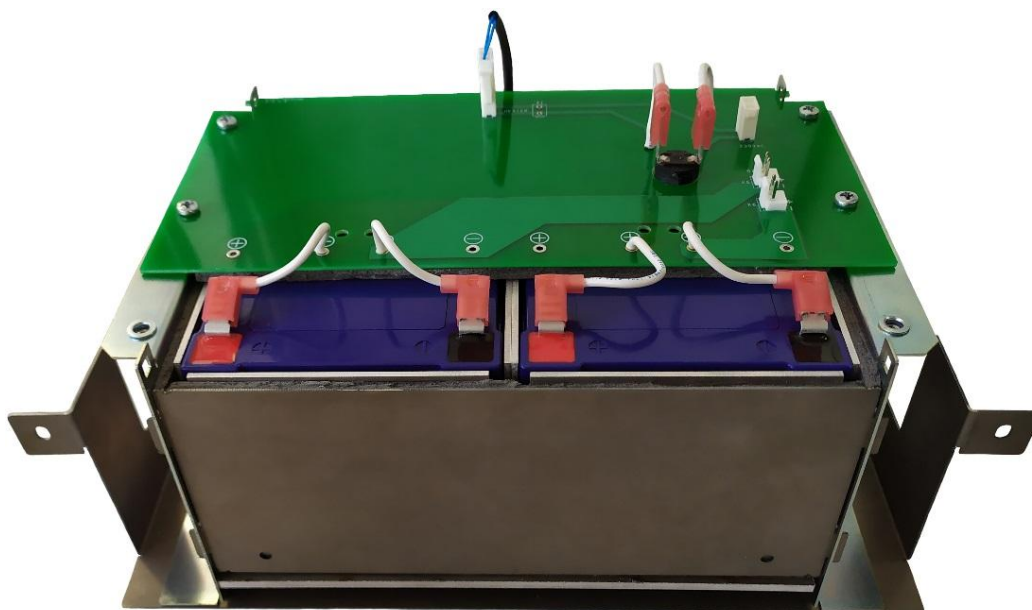

Figure 7.5 – Connected batteries.

### IMPORTANT!

- During installation be careful not to short-circuit the battery terminals with holders.
- 230 VAC voltage is supplied to the thermocouple.

The switch is designed to prevent incorrect battery connection. However, if that happens, Polarity Mistake indicator will light up only for the battery that was installed incorrectly.

## 7.6 Power supply connection

The switch is connected to 230VAC source. Power supply cable is pulled into the unit through PG13,5 cable gland and is connected to the power supply unit (section 3.5).

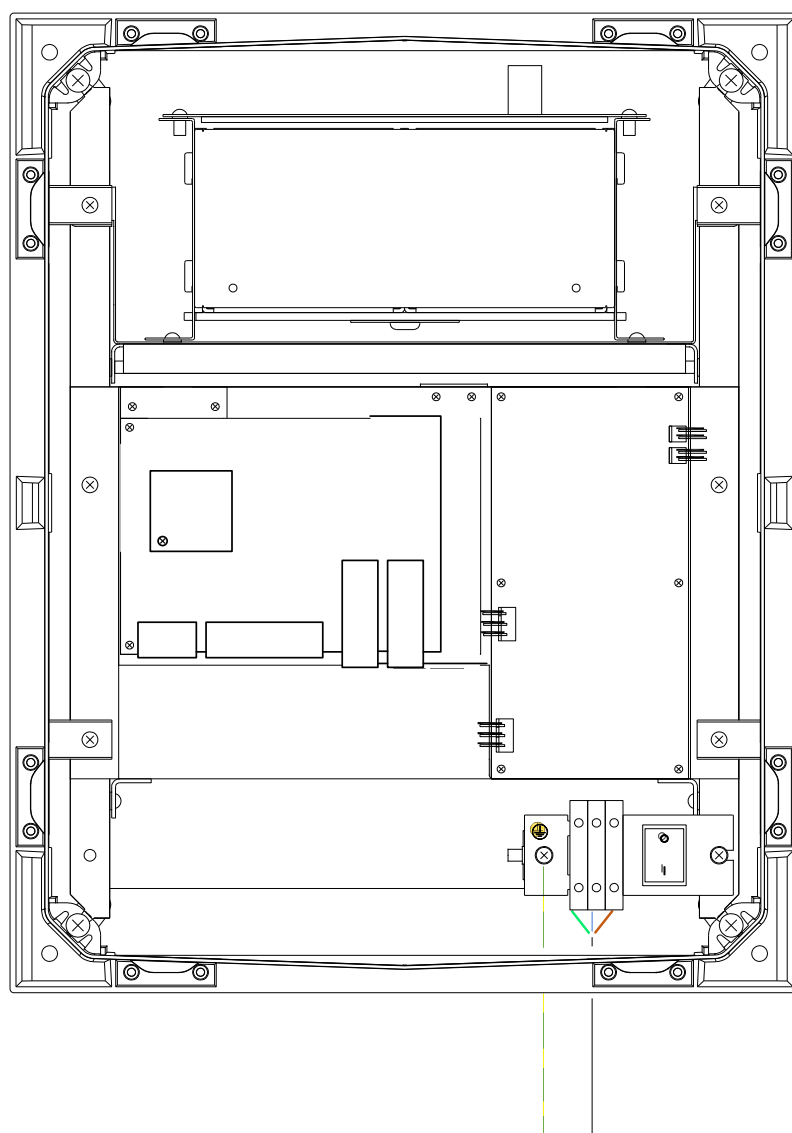

Figure 7.6 – Switch connection scheme.

## 7.7 Camera connection

Camera connection recommendations:

1. Use a 4-pair shielded twisted pair, at least category 5
2. Use shielded RJ45 connections



3. Use minimum length of cables coming to video cameras
4. Avoid parallel installation of twisted pair and power cables

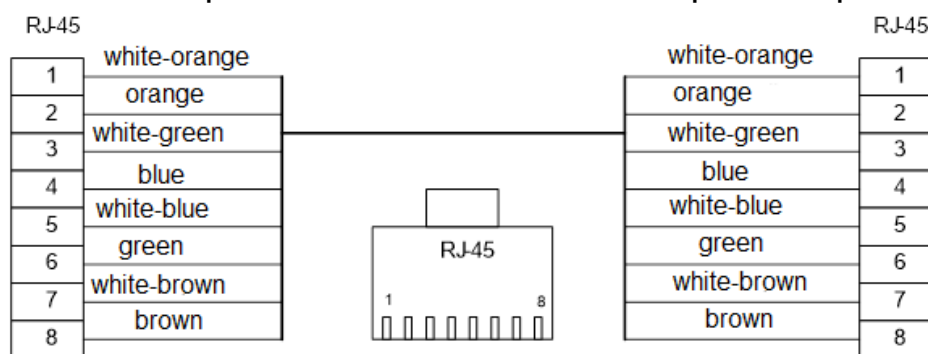

Figure 7.7 - Standard cable separation.

## 8 Manufacturer's warranty

The warranty period for the switch is 3 years from the date of sale. Only a complete switch is accepted for servicing and repair. Warranty shall not apply in the following cases:

- if the warranty period has expired;
- if manufacturer's marking with the serial number on the housing is missing or if the serial number has been changed, removed or is illegible;
- if there are internal or external mechanical damages (chipping, cracking, deformation, damaged power supply wires, cracking or splitting of the terminals), signs of treatment with aggressive chemicals or fluids, severe contamination, insects presence or signs of insects presence;
- in case of improper connection and operation of the switch or if power supply parameters do not meet the requirements specified in this operating manual;
- if the switch was damaged as a result of force majeure, due to the actions of third parties or other reasons beyond manufacturer's control.

## 9 Technical support

To get technical support for the design of video surveillance systems, operation and adjustment of equipment:

- call (8 a.m. to 4 p.m. Moscow time)  
+7 342 260-20-30
- e-mail: [tfortis@fort-telecom.ru](mailto:tfortis@fort-telecom.ru)

All technical documentation is available at:

<https://tfortis.com/support/dokumentaciya-na-produkciyu/>